

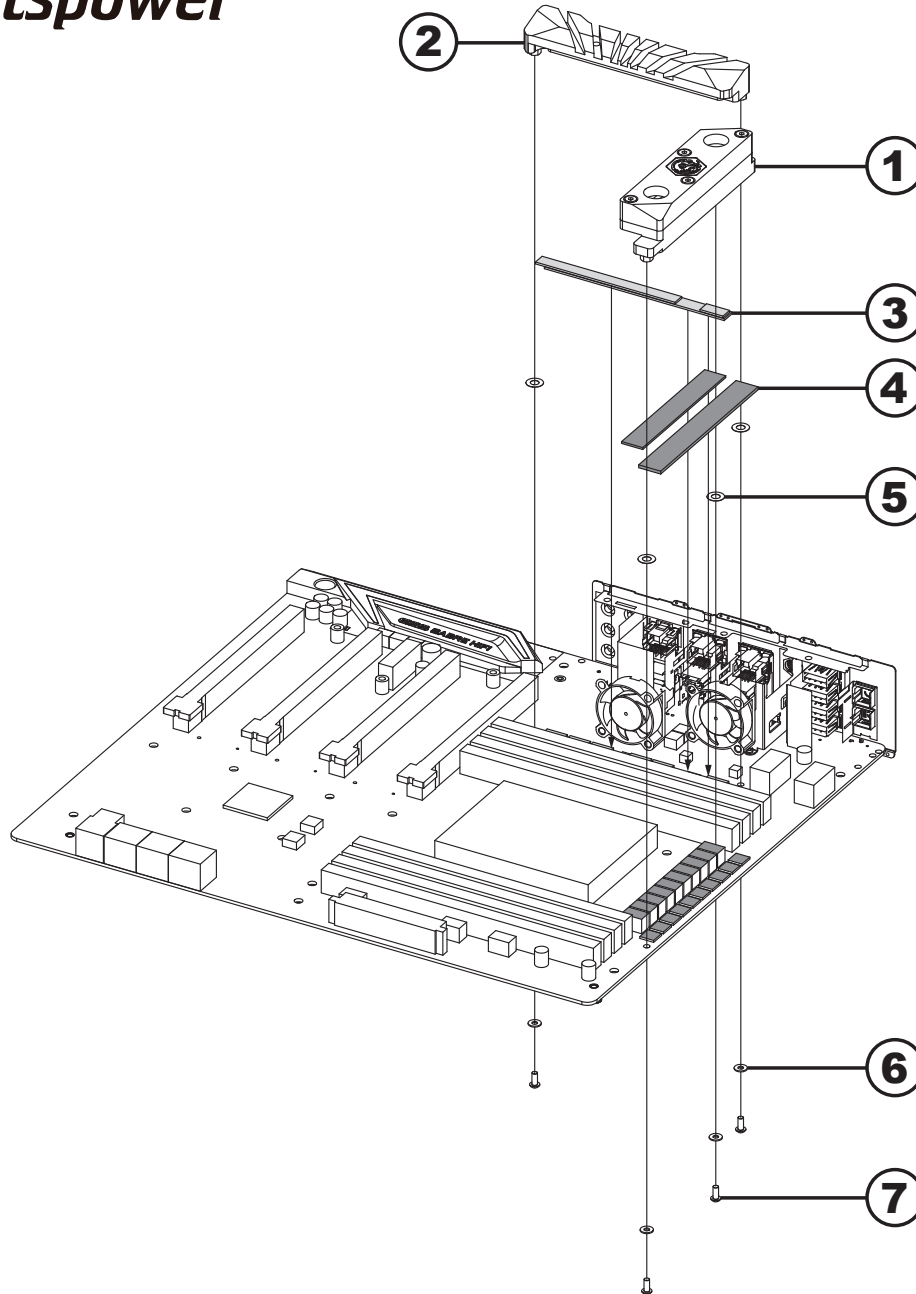

Bitspower®



GIGABYTE X399 AORUS XTREME

配 件

①	BP-MBGAX399X	1 組
②	BP 盔甲	1 個
③	1.0 毫米導熱墊片	2 片
④	1.5 毫米導熱墊片	1 片
⑤	背膠華司	4 片
⑥	塑膠華司	4 片
⑦	M2.5 x 6 毫米螺絲	4 支

Accessories

①	BP-MBGAX399X	1 SET
②	BP Armor	1 PCS
③	1.0 mm Thermal Pad	2 PCS
④	1.5 mm Thermal Pad	1 PCS
⑤	Washer With Gum	4 PCS
⑥	Washer	4 PCS
⑦	M2.5 x 6 mm Screw	4 PCS

配 件

①	BP-MBGAX399X	1 組
②	BP 盔甲	1 個
③	1.0 毫米導熱墊片	2 片
④	1.5 毫米導熱墊片	1 片
⑤	背膠華司	4 片
⑥	塑膠華司	4 片
⑦	M2.5 x 6 毫米螺絲	4 支





本公司保留對產品的設計更改以及解釋的權力。如有更動恕不另行通知。產品顏色與配件以實物為準。

Bitspower reserves the right to change the product design and interpretations. These are subject to change without notice. Product colors and accessories are based on the actual product.



本公司保留對產品的設計更改以及解釋的權力。如有更動恕不另行通知。產品顏色與配件以實物為準。





導熱墊片和導熱膏的正確應用位置

-  適量使用導熱膏
-  1 MM導熱墊片
-  1.5 MM導熱墊片

Applying The Thermal PAD And Thermal Paste On Correct Positions.

-  Using Appropriate Amount Of Thermal Paste.
-  1 MM THERMAL PAD
-  1.5 MM THERMAL PAD

导热垫片和导热膏的正确应用位置

-  适量使用导热膏
-  1 毫米导热垫片
-  1.5 毫米导热垫片

 注意：跑水前，請先確認所有零件已安裝在正確的位置上。在不開主機，單開水泵的情況下，進行24小時的跑水測試。確保無漏水情況後再開主機，避免發生漏水而導致電腦零件的損壞。

 Before filling in the water, please make sure all the components are installed correctly. To prevent any leakage which may damage the PC components, please perform a 24-hour leaking test with only the pump connected to the power supply .

 注意：跑水前，請先確認所有零件已安裝在正確的位置上。在不開主機，單開水泵的情況下，進行24小時的跑水測試。確保無漏水情況後再開主機，避免發生漏水而導致電腦零件的損壞。



Bitspower[®]

注意：Bitspower建議消費者使用蒸餾水、純淨水，加入Bitspower的染劑作為水冷液使用；如客戶自行選購的水冷液導致電鍍層剝落、水道堵塞、水泵轉

 動不正常、水箱管破裂或密封圈變型以致漏水等及其它不可抗力之問題時，消費者自行承擔相關產品責任。
未注水前，請勿啟動水泵電源。

Notice:Bitspower recommends that consumers add the Bitspower dye to distilled water or purified water for their water-cooling liquid. If the

 consumer chooses different water-cooling liquids, the resulting impurities may cause peeling of the coating on some of the hardware, water channels blockage by built-up residue, improper operation of the water pump, water tank tube breakage, and o-rings deformation leading to leakage. Any issues related to the use of inappropriate water-cooling liquid will be the responsibility of the consumer.
Do not turn on the pump if the reservoir is empty.

注意：Bitspower 建议消费者使用蒸馏水、纯净水，加入Bitspower的染剂作为水冷液使用；如客户自行选购的水冷液导致电镀层剥落、水道堵塞、水泵转

 动不正常、水箱管破裂或密封圈变型以致漏水等及其它不可抗力之问题时，消费者自行承担相关产品责任。
未注水前，请勿启动水泵电源。



注意·跑水前·請先確認所有零件已安裝在正確的位置上·在不開主機·單開水泵的情況下·進行24小時的跑水測試·確保無漏水情況後再開主機·避免發生漏水而導致電腦零件的損壞。
Before fill in water, please make sure all the component be installed correctly, avoiding leaking happen and destroy the PC component.

注意·跑水前·請先確認所有零件已安裝在正確的位置上·在不開主機·單開水泵的情況下·進行24小時的跑水測試·確保無漏水情況後再開主機·避免發生漏水而導致電腦零件的損壞。

本公司保留對產品的設計更改以及解釋的權力·如有更動恕不另行通知·產品顏色與配件以實物為準。

Bitspower reserves the right to change the product design and interpretations. These are subject to change without notice. Product colors and accessories are based on the actual product.

本公司保留對產品的設計更改以及解釋的權力·如有更動恕不另行通知·產品顏色與配件以實物為準。