

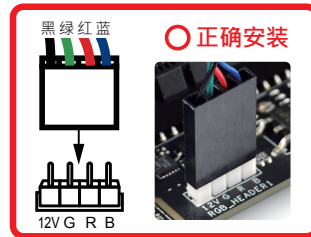

Bitspower®

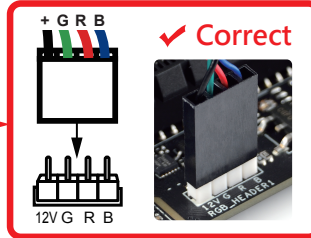
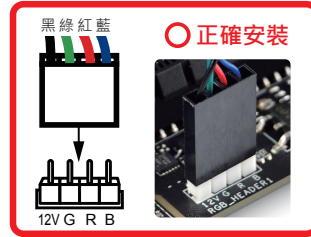
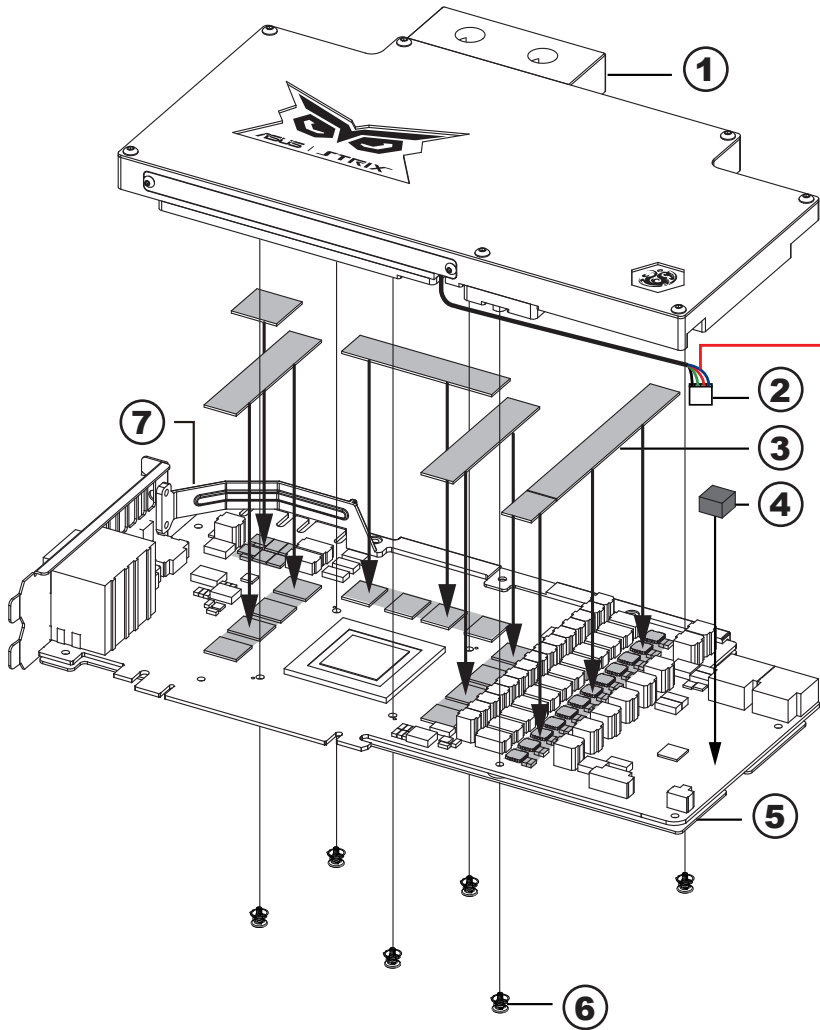

安裝說明

專為ASUS STRIX-GTX980TI-DC3(OC)-6GD5-GAMING顯示卡設計

- ① BP-N980TIAS_RGB
- ② LED燈(適用主機板LED RGB插槽)
- ③ 1 MM導熱墊片
- ④ 硬海綿
- ⑤ 原廠背板
- ⑥ 彈簧螺絲
- ⑦ 原廠支架

備品零件不全適用本產品
請依產品實際配件為主。

備品零件

↓ M2.5x10 MM螺絲	2支
↓ M2.5x 6 MM螺絲	2支
● 增高螺絲	2個

Installation Guide

Designed for ASUS STRIX-GTX980TI-DC3(OC)-6GD5-GAMING

- ① BP-N980TIAS_RGB
- ② LED (Applicable LED RGB motherboard slot.)
- ③ 1 MM THERMAL PAD
- ④ Hard sponge
- ⑤ Original Backplane
- ⑥ Spring Screw
- ⑦ Support

Spare parts incomplete application of this product.
Please dominated by actual product accessories.

Spare Screws

↓ M2.5x10 MM SCREW	2 PCS
↓ M2.5x 6 MM SCREW	2 PCS
● SCREW	2 PCS

安裝說明

專為ASUS STRIX-GTX980TI-DC3(OC)-6GD5-GAMING 示卡設計

- ① BP-N980TIAS_RGB
- ② LED燈(適用主機板LED RGB插槽)
- ③ 1 毫米導熱墊片
- ④ 硬海綿
- ⑤ 原廠背板
- ⑥ 彈簧螺絲
- ⑦ 原廠支架

備品零件不全適用本產品
請依產品實際配件為主。

備品零件

↓ M2.5x10毫米螺絲	2支
↓ M2.5x 6 毫米螺絲	2支
● 增高螺絲	2個



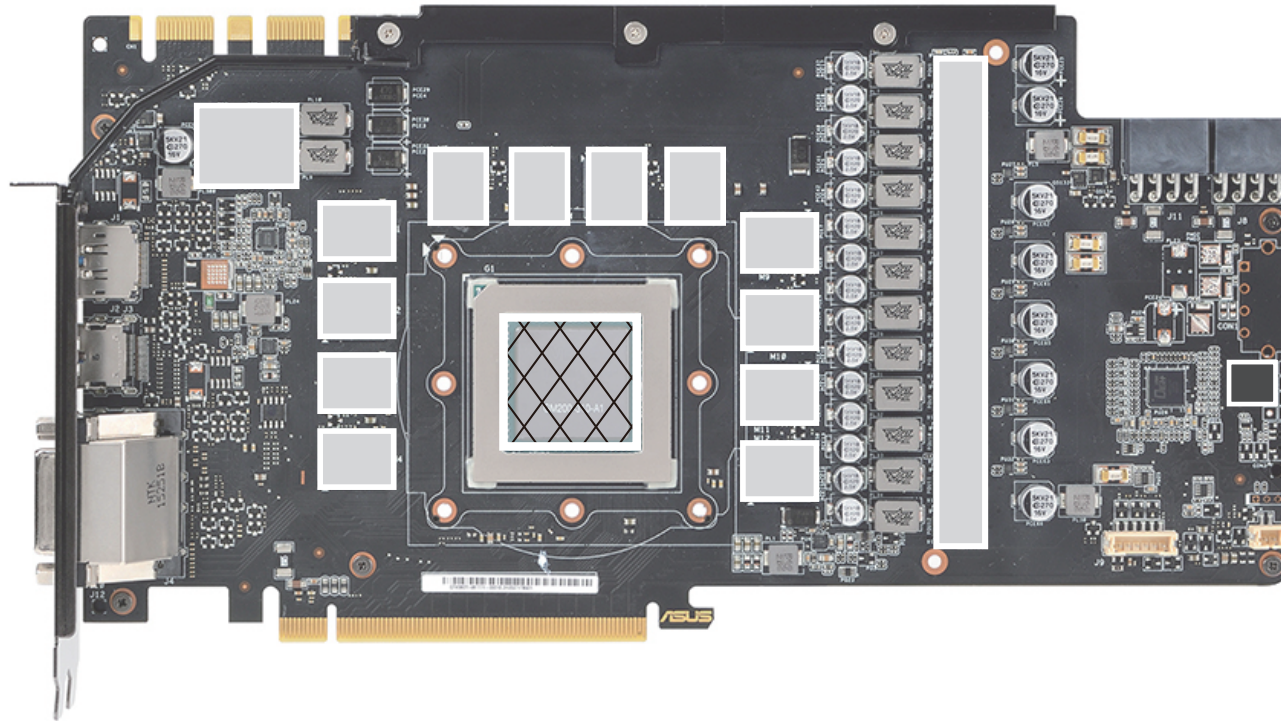

Bitspower®





導熱墊片和導熱膏的正確應用位置

-  適量使用導熱膏
-  1 MM導熱墊片
-  硬海綿

Applying The Thermal PAD And Thermal Paste On Correct Positions.

-  Using Appropriate Amount Of Thermal Paste.
-  1 MM THERMAL PAD
-  Hard sponge

导热垫片和导热膏的正确应用位置

-  适量使用导热膏
-  1 毫米导热垫片
-  硬海绵

⚠ 注意 注意，跑水前，請先確認所有零件已安裝在正確的位置上，在不開主機，單開水泵的情況下，進行24小時的跑水測試，確保無漏水情況後再開主機，避免發生漏水而導致電腦零件的損壞。

⚠ Important Before fill in water, please make sure all the component be installed correctly, avoiding leaking happen and destroy the PC component.

⚠ 注意 注意，跑水前，請先確認所有零件已安裝在正確的位置上，在不開主機，單開水泵的情況下，進行24小時的跑水測試，確保無漏水情況後再開主機，避免發生漏水而導致電腦零件的損壞。