



Bitspower®

ASUS ROG MAXIMUS XI EXTREME

配件

①	BP-MBASMxie	1 組
②	1.5 毫米導熱墊片	3 片
③	背膠華司	8 片
④	塑膠華司	4 片
⑤	M2.5 x 6 毫米螺絲	4 支
⑥	背板墊片	1 片
⑦	3M背膠絕緣片	1 片
⑧	金屬背板	1 片
⑨	M3 x 10 毫米螺絲	4 支

Accessories

①	BP-MBASMxie	1 SET
②	1.5 mm Thermal pad	3 PCS
③	Washer With Gum	8 PCS
④	Washer	4 PCS
⑤	M2.5 x 6 mm Screw	4 PCS
⑥	Back Pad	1 PCS
⑦	3M Paste pad	1 PCS
⑧	Metal backplane	1 PCS
⑨	M3 x 10 mm Screw	4 PCS

配件

①	BP-MBASMxie	1 組
②	1.5 毫米導熱墊片	3 片
③	背膠華司	8 片
④	塑膠華司	4 片
⑤	M2.5 x 6 毫米螺絲	4 支
⑥	背板墊片	1 片
⑦	3M背膠絕緣片	1 片
⑧	金屬背板	1 片
⑨	M3 x 10 毫米螺絲	4 支

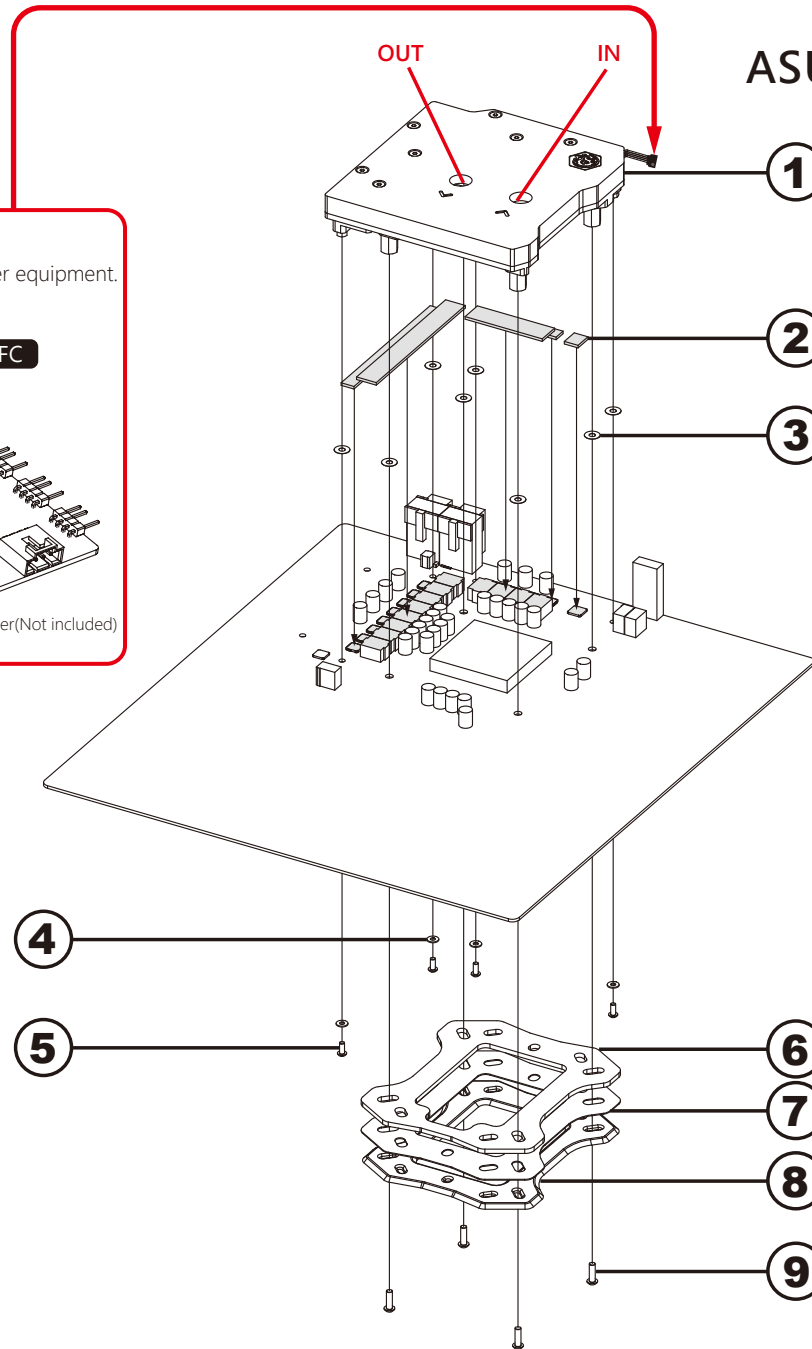

請接 ①主版或 ②其他設備的DRGB插槽。

Digital RGB PIN on ①motherboard or ②other equipment.

請接 ①主版或 ②其他設備的DRGB插槽。

① ② → BPTA-DRGBMFC

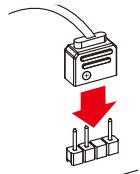

主版
motherboard
主版

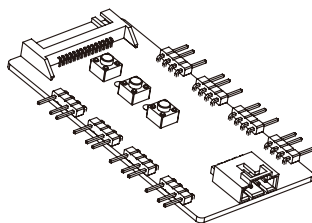

DRGB控制器(不包括)
DRGB Multi Function Controller(Not included)
DRGB控制器(不包括)



本公司保留對產品的設計更改以及解釋的權力，如有更動恕不另行通知，產品顏色與配件以實物為準。

Bitspower reserves the right to change the product design and interpretations. These are subject to change without notice. Product colors and accessories are based on the actual product.

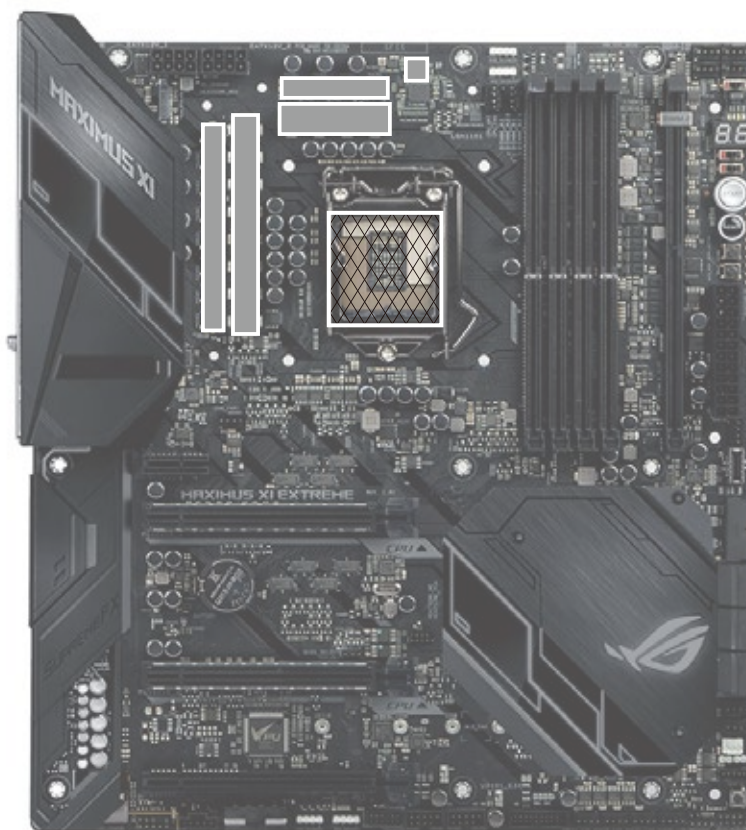

本公司保留對產品的設計更改以及解釋的權力，如有更動恕不另行通知，產品顏色與配件以實物為準。





導熱墊片和導熱膏的正確應用位置

-  適量使用導熱膏
-  1.5 MM 導熱墊片

Applying the thermal pad and thermal paste on correct positions.

-  Using appropriate amount of thermal paste.
-  1.5 mm Thermal pad

导热垫片和导热膏的正确应用位置

-  适量使用导热膏
-  1.5 毫米导热垫片

 注意：跑水前，請先確認所有零件已安裝在正確的位置上。在不開主機，單開水泵的情況下，進行24小時的跑水測試，確保無漏水情況後再開主機，避免發生漏水而導致電腦零件的損壞。

 Before filling in the water, please make sure all the components are installed correctly. To prevent any leakage which may damage the PC components, please perform a 24-hour leaking test with only the pump connected to the power supply.

 注意：跑水前，請先確認所有零件已安裝在正確的位置上。在不開主機，單開水泵的情況下，進行24小時的跑水測試，確保無漏水情況後再開主機，避免發生漏水而導致電腦零件的損壞。



Bitspower[®]

注意：Bitspower建議消費者使用蒸餾水、純淨水，加入Bitspower的染劑作為水冷液使用；如客戶自行選購的水冷液導致電鍍層剝落、水道堵塞、水泵轉

 動不正常、水箱管破裂或密封圈變型以致漏水等及其它不可抗力之問題時，消費者自行承擔相關產品責任。
未注水前，請勿啟動水泵電源。

Notice:Bitspower recommends that consumers add the Bitspower dye to distilled water or purified water for their water-cooling liquid. If the

 consumer chooses different water-cooling liquids, the resulting impurities may cause peeling of the coating on some of the hardware, water channels blockage by built-up residue, improper operation of the water pump, water tank tube breakage, and o-rings deformation leading to leakage. Any issues related to the use of inappropriate water-cooling liquid will be the responsibility of the consumer.
Do not turn on the pump if the reservoir is empty.

注意：Bitspower 建议消费者使用蒸馏水、纯净水，加入Bitspower的染剂作为水冷液使用；如客户自行选购的水冷液导致电镀层剥落、水道堵塞、水泵转

 动不正常、水箱管破裂或密封圈变型以致漏水等及其它不可抗力之问题时，消费者自行承担相关产品责任。
未注水前，请勿启动水泵电源。



注意·跑水前·請先確認所有零件已安裝在正確的位置上·在不開主機·單開水泵的情況下·進行24小時的跑水測試·確保無漏水情況後再開主機·避免發生漏水而導致電腦零件的損壞。
Before fill in water,please make sure all the component be installed correctly,avoidingleaking happen and destroy the PC component.

注意·跑水前·請先確認所有零件已安裝在正確的位置上·在不開主機·單開水泵的情況下·進行24小時的跑水測試·確保無漏水情況後再開主機·避免發生漏水而導致電腦零件的損壞。

本公司保留對產品的設計更改以及解釋的權力·如有更動恕不另行通知·產品顏色與配件以實物為準。

Bitspower reserves the right to change the product design and interpretations. These are subject to change without notice. Product colors and accessories are based on the actual product.

本公司保留對產品的設計更改以及解釋的權力·如有更動恕不另行通知·產品顏色與配件以實物為準。