



### Parts List

**A** 顯卡冷頭 / VGA Water Block / 显卡冷头

**B** 接頭 / Fitting / 接头

B-1 BPTA-DOTFH1622.....4 pcs

B-2 BPTA-90RE-GS.....6 pcs

B-3 BPTA-60RE-GS.....1 pcs

B-4 TA-F40-GS.....1 pcs

**C** 配件 / Accessory / 配件

C-1 硬管 / Hard tube / 硬管.....2 pcs

C-2 M2.5 x 10 螺絲 / Screw / 螺丝.....14 pcs

C-3 M2.5 Nut 螺母 / Nut / 螺絲.....1 pcs

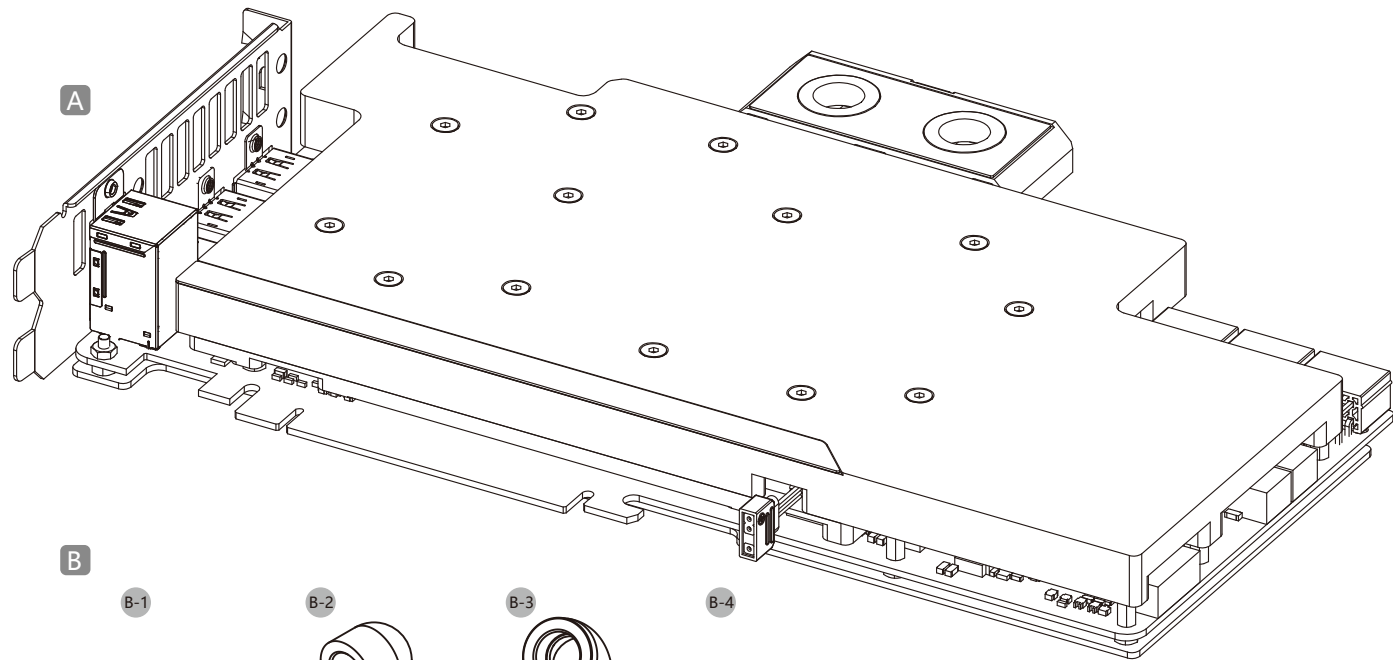

以上數量包含預安裝  
The above quantity includes pre-installation  
以上數量包含預安裝

**C**

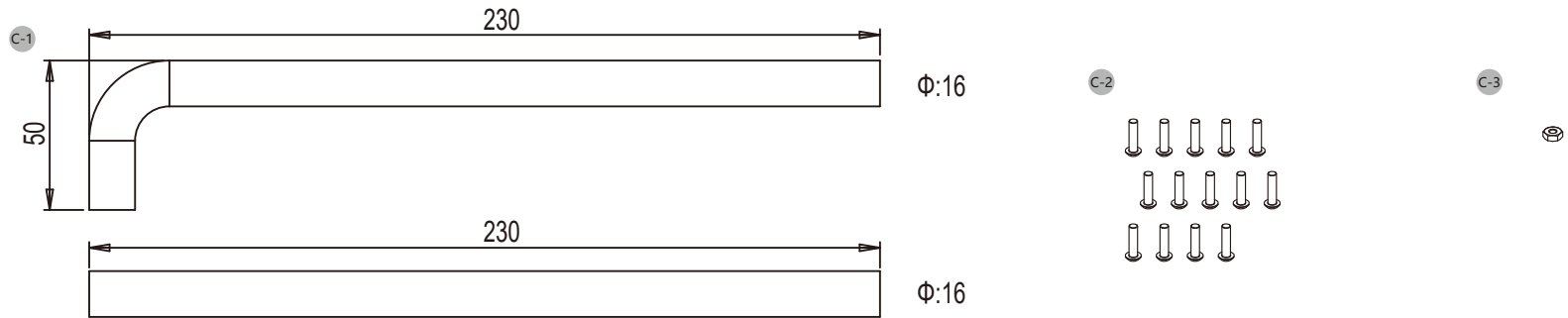

※ The allowable variance in tube length is ± 2mm



注意·跑水前·請先確認所有零件已安裝在正確的位置上·在不開主機·單開水泵的情況下·進行24小時的跑水測試·確保無漏水情況後再開主機·避免發生漏水而導致電腦零件的損壞·

Before fill in water, please make sure all the component be installed correctly, avoiding leaking happen and destroy the PC component.

注意·跑水前·請先確認所有零件已安裝在正確的位置上·在不開主機·單開水泵的情況下·進行24小時的跑水測試·確保無漏水情況後再開主機·避免發生漏水而導致電腦零件的損壞·

本公司保留對產品的設計更改以及解釋的權力·如有更動恕不另行通知·產品顏色與配件以實物為準·

Bitspower reserves the right to change the product design and interpretations. These are subject to change without notice. Product colors and accessories are based on the actual product.

本公司保留對產品的設計更改以及解釋的權力·如有更動恕不另行通知·產品顏色與配件以實物為準·



# Design for ASUS ROG Strix GeForce RTX 3090

請撕下銘板保護膜  
Please tear off the protective film on the mirror plate.

請接 ① 主板或 ② 其他設備的 DRGB 插槽。  
Digital RGB PIN on ① motherboard or ② other equipment.  
請接 ① 主板或 ② 其他設備的 DRGB 插槽。

① 主板  
motherboard  
主版

② BPTA-DRGBMFC  
DRGB 控制器(不包括)  
DRGB Multi Function Controller(Not included)  
DRGB 控制器(不包括)

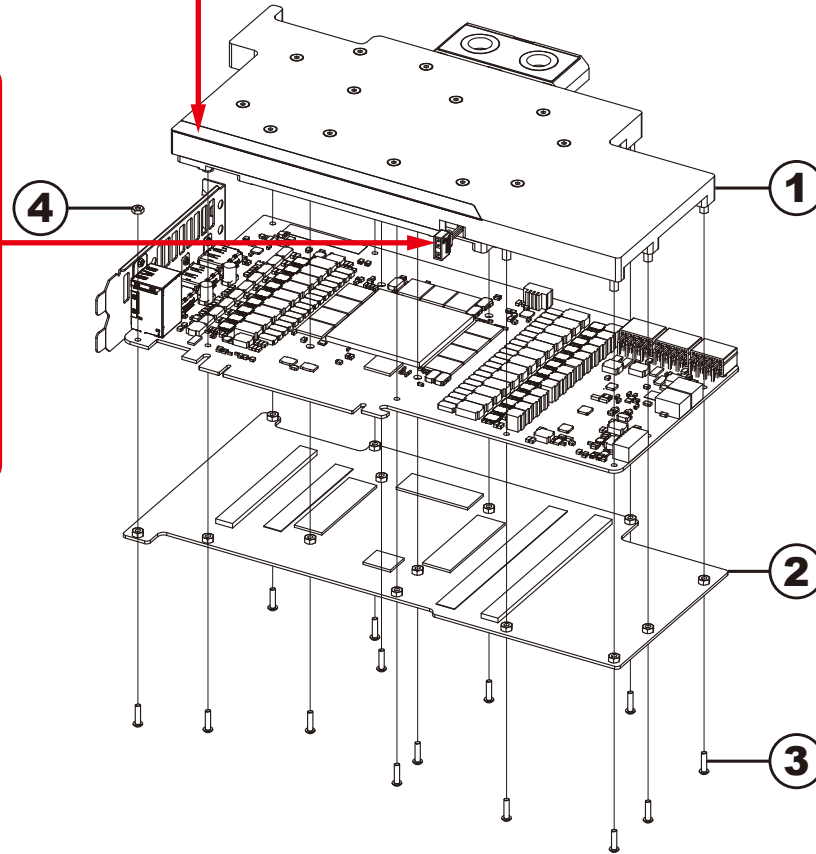

## 配件

- ① 顯卡冷頭 1 組
- ② 背板 1 片
- ③ M2.5 x 10 螺絲 14 支
- ④ M2.5 螺母 1 個

## Accessories

- ① Waterblock 1 PCS
- ② Back plate 1 PCS
- ③ M2.5 x 10 screw 14 PCS
- ④ M2.5 Nut 1 PCS

## 配件

- ① 显卡冷头 1 组
- ② 背板 1 片
- ③ M2.5 x 10 螺丝 14 支
- ④ M2.5 螺母 1 个

請從冷頭拆下背板後再依照說明書，把冷頭、背板安裝到顯卡上。  
Please remove the back plate from the waterblock, and then follow the installation guide to install the waterblock, and a back plate with your graphics card.  
請從冷頭拆下背板后再按照说明书，把冷頭、背板安裝到插件上。





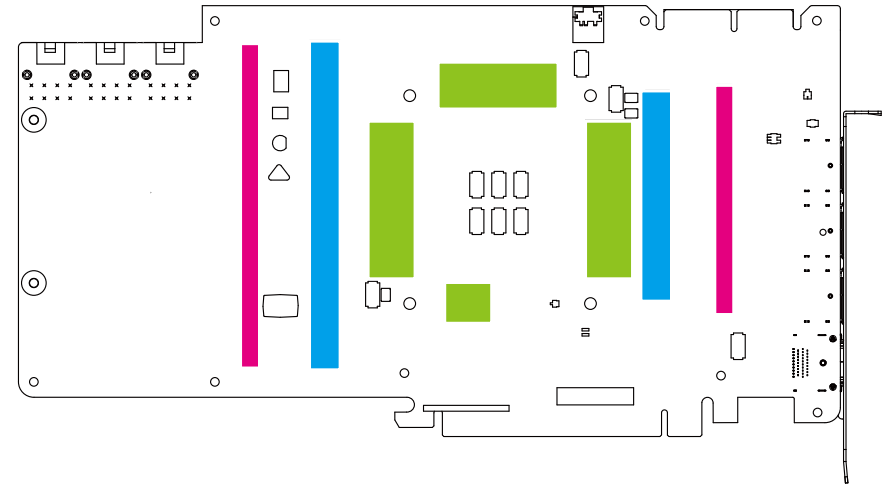
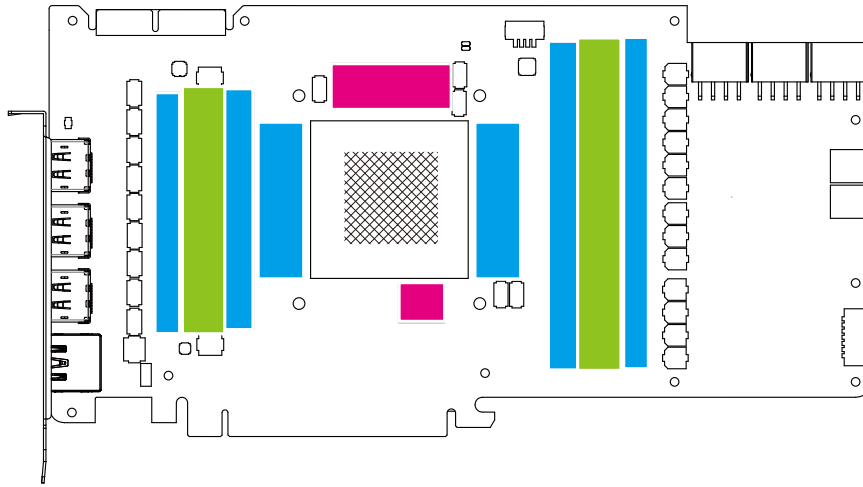

本公司保留對產品的設計更改以及解釋的權力，如有更動恕不另行通知，產品顏色與配件以實物為準。  
Bitspower reserves the right to change the product design and interpretations. These are subject to change without notice. Product colors and accessories are based on the actual product.  
本公司保留对产品的設計更改以及解釋的權力，如有更動恕不另行通知，產品顏色與配件以實物為準。







## ASUS ROG Strix GeForce RTX 3090



### 導熱墊片和導熱膏的正確應用位置

-  適量使用導熱膏
-  1.0 mm 導熱墊片
-  2.0 mm 導熱墊片
-  2.5 mm 導熱墊片

### Applying the thermal pad and thermal paste on correct positions.

-  Using appropriate amount of thermal paste.
-  1.0 mm Thermal pad
-  2.0 mm Thermal pad
-  2.5 mm Thermal pad

### 导热垫片和导热膏的正确应用位置

-  适量使用导热膏
-  1.0 毫米导热垫片
-  2.0 毫米导热垫片
-  2.5 毫米导热垫片

 Before filling in the water, please make sure all the components are installed correctly. To prevent any leakage which may damage the PC components, please perform a 24-hour leaking test with only the pump connected to the power supply.

 注意：跑水前，请先确认所有零件已安装在正确的位置上。在不关主机，单开水泵的情况下，进行24小时的跑水测试，确保无漏水情况后，再开主机，避免发生漏水而导致电脑零件的损坏。

注意：跑水前，请先确认所有零件已安装在正确的位置上。在不关主机，单开水泵的情况下，进行24小时的跑水测试，确保无漏水情况后，再开主机，避免发生漏水而导致电脑零件的损坏。

注意：跑水前，请先确认所有零件已安装在正确的位置上。在不关主机，单开水泵的情况下，进行24小时的跑水测试，确保无漏水情况后，再开主机，避免发生漏水而导致电脑零件的损坏。

請撕下銘板保護膜  
Please tear off the protective film on the mirror plate.

請接 ① 主版或 ② 其他設備的 DRGB 插槽。  
Digital RGB PIN on ① motherboard or ② other equipment.  
請接 ① 主版或 ② 其他設備的 DRGB 插槽。

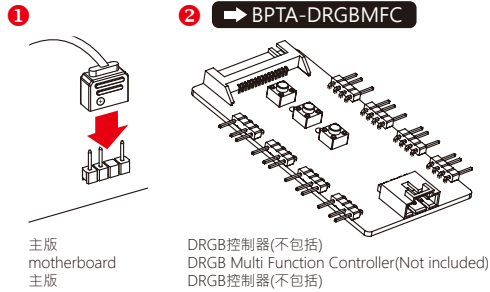

導熱墊片需另外購買  
Thermal pad sold separately  
导热垫片需另外购买

請從冷頭拆下背板後再依照說明書，把冷頭、背板安裝到顯卡上。  
Please remove the back plate from the waterblock, and then follow the installation guide to install the waterblock, and a back plate with your graphics card.  
請從冷頭拆下背板後再按照說明書，把冷頭、背板安裝到插件上。

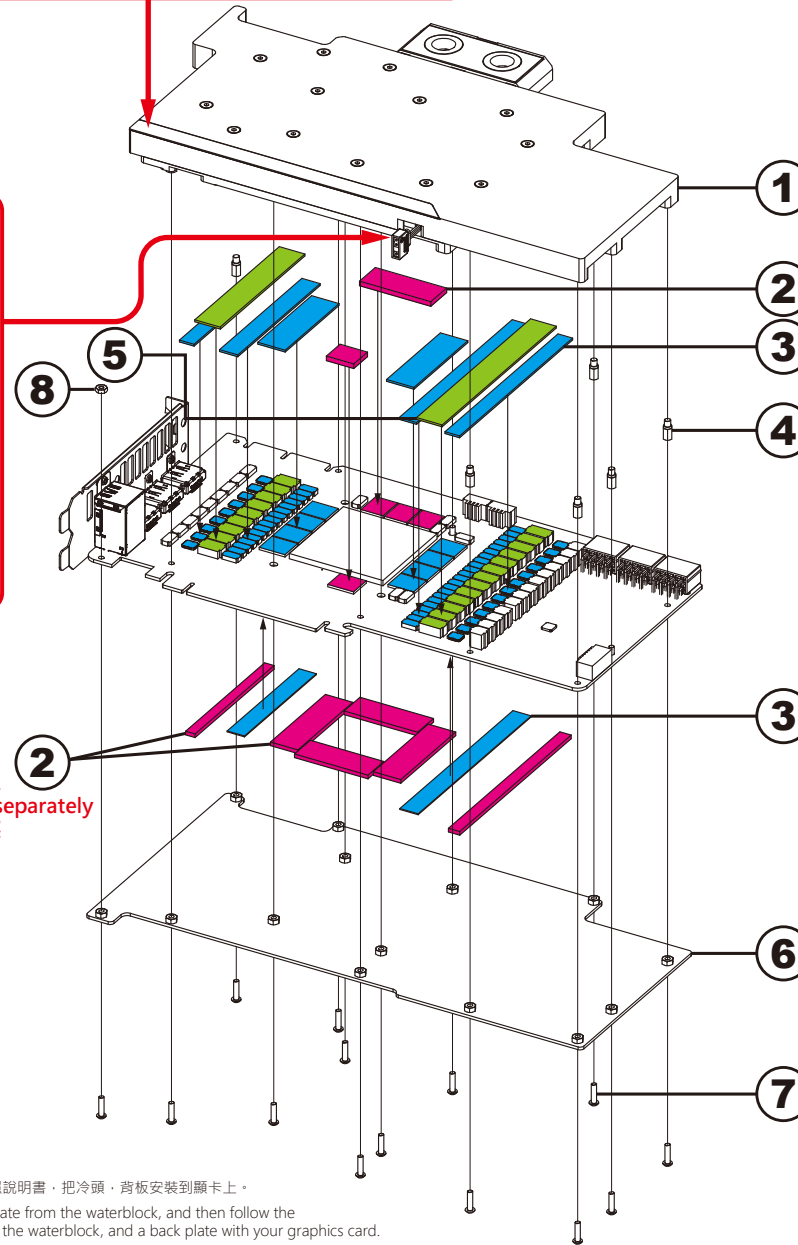

## 配件

①	顯卡冷頭	1 組
②	2.5 mm 導熱墊片	4 片
③	1.0 mm 導熱墊片	5 片
④	墊高螺絲 (已鎖上)	6 支
⑤	2.0 mm 導熱墊片	2 片
⑥	背板	1 片
⑦	M2.5 x 10 螺絲	14 支
⑧	M2.5 螺母	1 個

## Accessories

①	Waterblock	1 PCS
②	2.5 mm Thermal pad	4 PCS
③	1.0 mm Thermal pad	5 PCS
④	Booster screw (Has been Installed)	6 PCS
⑤	2.0 mm Thermal pad	2 PCS
⑥	Back plate	1 PCS
⑦	M2.5 x 10 screw	14 PCS
⑧	M2.5 Nut	1 PCS

## 配件



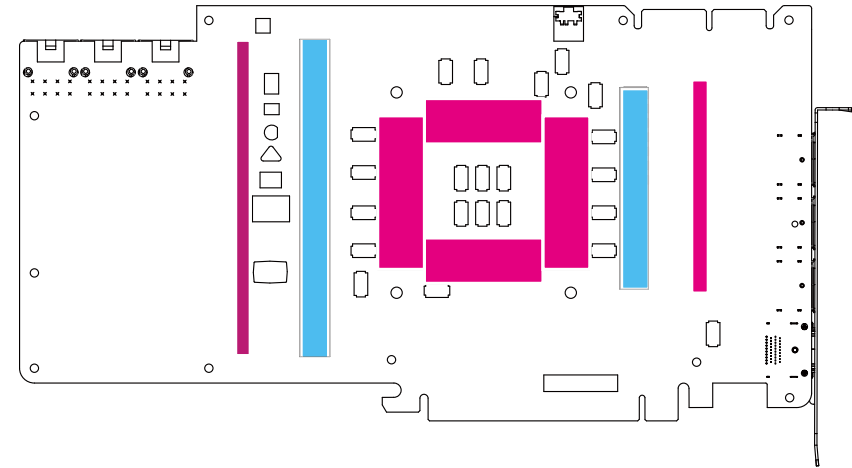
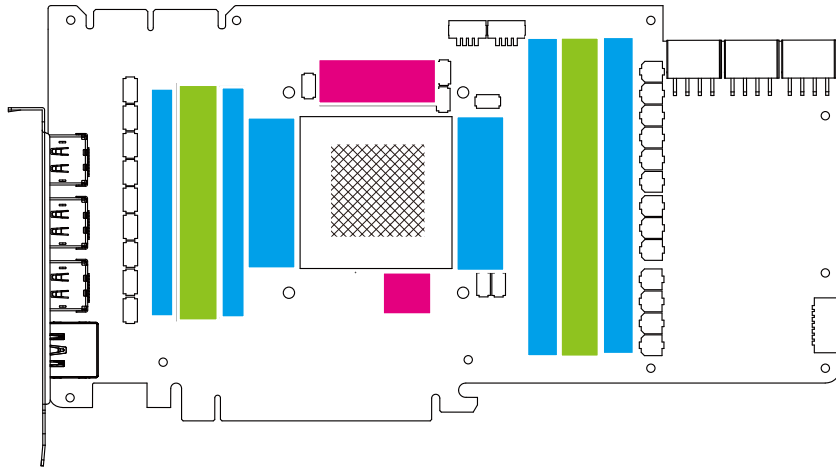

①	显卡冷头	1 组
②	2.5 mm 导热垫片	4 片
③	1.0 mm 导热垫片	5 片
④	垫高螺丝 (已锁上)	6 支
⑤	2.0 mm 导热垫片	2 片
⑥	背板	1 片
⑦	M2.5 x 10 螺丝	14 支
⑧	M2.5 螺母	1 个









## ASUS ROG Strix GeForce RTX 3080





### 導熱墊片和導熱膏的正確應用位置

-  適量使用導熱膏
-  1.0 mm 導熱墊片
-  2.0 mm 導熱墊片
-  2.5 mm 導熱墊片

### Applying the thermal pad and thermal paste on correct positions.

-  Using appropriate amount of thermal paste.
-  1.0 mm Thermal pad
-  2.0 mm Thermal pad
-  2.5 mm Thermal pad

### 导热垫片和导热膏的正确应用位置

-  适量使用导热膏
-  1.0 毫米导热垫片
-  2.0 毫米导热垫片
-  2.5 毫米导热垫片

 Before filling in the water, please make sure all the components are installed correctly. To prevent any leakage which may damage the PC components, please perform a 24-hour leaking test with only the pump connected to the power supply.

 注意·跑水前·请先确认所有零件已安装在正确的位置上·在不关主机·单开水泵的情况下·进行24小时的跑水测试·确保无漏水情况后开主机·避免发生漏水而导致电脑零件的损坏。

 注意·跑水前·请先确认所有零件已安装在正确的位置上·在不关主机·单开水泵的情况下·进行24小时的跑水测试·确保无漏水情况后开主机·避免发生漏水而导致电脑零件的损坏。

## ◀ 要求安裝方式/Required installation method/要求安裝方式

### 主件說明 / Accessories/ 主件說明

- A** 顯卡冷頭 / VGA Water Block / 显卡冷头
- B-1** BPTA-DOTFH1622-GS
- B-2** BPTA-90RE-GS
- B-3** BPTA-60RE-GS
- B-4** TA-F40-GS
- C** 硬管 / Hard tube / 硬管

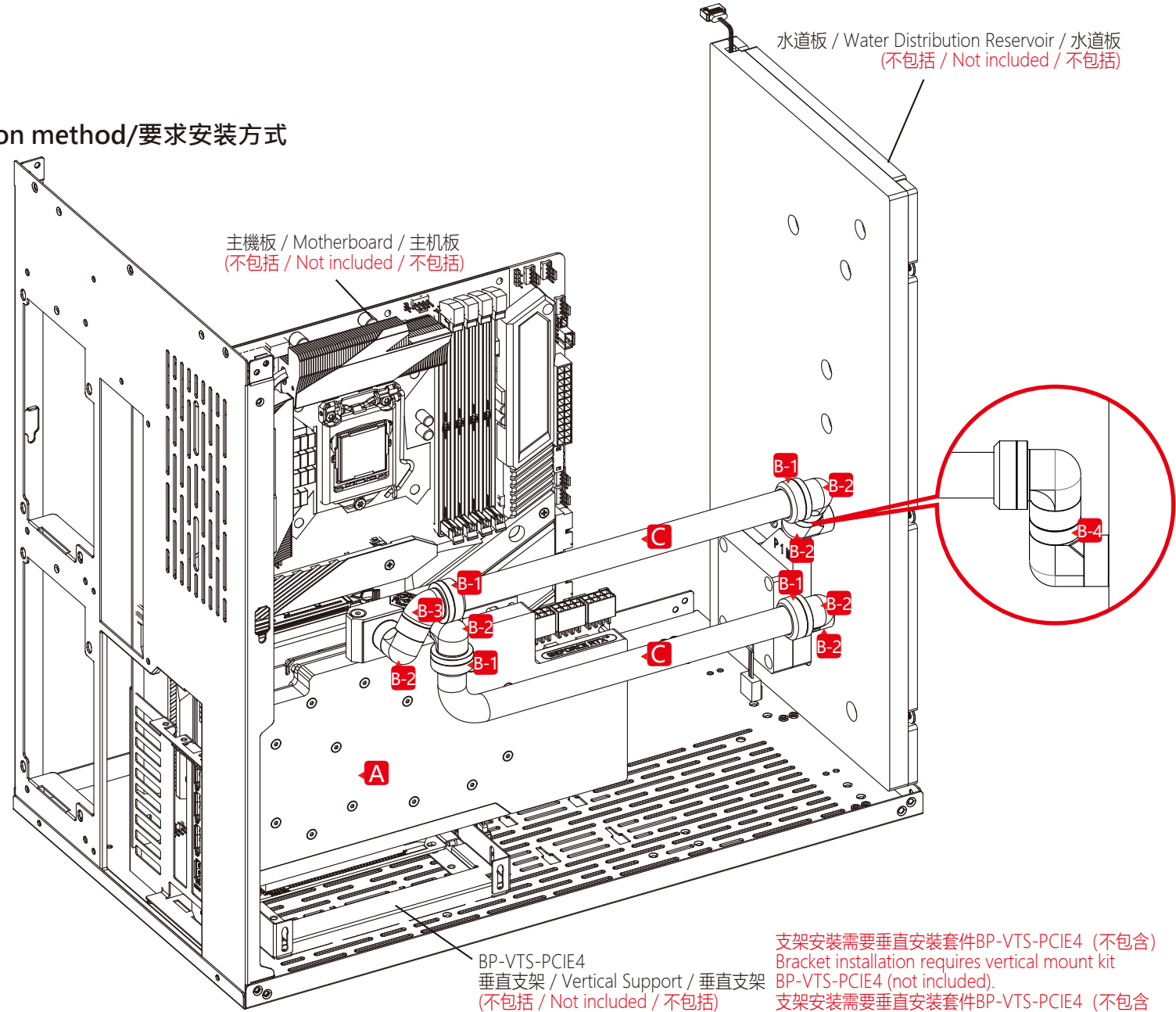

支架安裝需要垂直安裝套件BP-VTS-PCIE4 (不包含)  
 Bracket installation requires vertical mount kit  
 BP-VTS-PCIE4 (not included).  
 支架安裝需要垂直安裝套件BP-VTS-PCIE4 (不包含)



注意·跑水前·請先確認所有零件已安裝在正確的位置上·在不開主機·單開水泵的情況下·進行24小時的跑水測試·確保無漏水情況後再開主機·避免發生漏水而導致電腦零件的損壞·

Before fill in water, please make sure all the component be installed correctly, avoiding leaking happen and destroy the PC component.

注意·跑水前·請先確認所有零件已安裝在正確的位置上·在不開主機·單開水泵的情況下·進行24小時的跑水測試·確保無漏水情況後再開主機·避免發生漏水而導致電腦零件的損壞·

本公司保留對產品的設計更改以及解釋的權力·如有更動恕不另行通知·產品顏色與配件以實物為準·

Bitspower reserves the right to change the product design and interpretations. These are subject to change without notice. Product colors and accessories are based on the actual product.

本公司保留對產品的設計更改以及解釋的權力·如有更動恕不另行通知·產品顏色與配件以實物為準·



**Bitspower®**

**注意：**Bitspower要求消費者使用蒸餾水或純水或Bitspower透明冷卻液作為水冷液使用。此外，也可以添加Bitspower染料到透明冷卻液中以滿足顏色要求。如果消費者選擇不同的水冷液，可能會引起水路配件中的塗層剝落、積垢堵塞水道、水泵磨損、水箱管破裂、O型圈變形或失去密封性導致漏水等。任何因使用不當水冷液導致相關的問題將由消費者自行負責。

**Notice:**Bitspower requires to use of distilled or pure water or Bitspower Pellucid Coolant as the water-cooling liquid. Also, the consumer can add Bitspower Dye to Pellucid Coolant for the color requirement. But please do not add any biocide by yourself. If the consumer chooses different water-cooling liquids, the resulting impurities may cause peeling off the coating on some of the hardware, water channels blockage by built-up residue, improper operation of the water pump, water tank tube breakage, and O-rings deformation or loss sealing leading to leakage. Any issues related to the use of inappropriate water-cooling liquid will be the responsibility of the consumer

**注意：**Bitspower要求消費者使用蒸餾水或純水或Bitspower透明冷卻液作為水冷液使用。此外，也可以添加Bitspower染料到透明冷卻液中以滿足顏色要求。如果消費者選擇不同的水冷液，可能會引起水路配件中的塗層剝落、積垢堵塞水道、水泵磨損、水箱管破裂、O型圈變形或失去密封性導致漏水等。任何因使用不當水冷液導致相關的問題將由消費者自行負責。

**注意：**當使用測氣產品測試水路時，為避免由於壓力過大導致產品損壞，輸入的壓力請不要超過0.5kg/cm<sup>2</sup>(Bar)，如因壓力過大造成產品損壞，將由客戶自行承擔，嚴禁客戶在水路有水及水泵開啟的情況下進行氣體飽壓測試。

**Notice:**When using leak tester on water cooling loop, in order to avoid product damage due to excessive pressure, the input pressure should not exceed 0.5kg/cm<sup>2</sup> (Bar). If the product is damaged due to excessive pressure, it will be borne by the customer. Forbidden to use the leak tester when there is water in the loop or the pump is running.

**注意：**當使用測氣產品測試水路時，為避免由於壓力過大導致產品損壞，輸入的壓力請不要超過0.5kg/cm<sup>2</sup>(Bar)，如因壓力過大造成產品損壞，將由客戶自行承擔，嚴禁客戶在水路有水及水泵開啟的情況下進行氣體飽壓測試。



注意·跑水前·請先確認所有零件已安裝在正確的位置上·在不開主機·單開水泵的情況下·進行24小時的跑水測試·確保無漏水情況後再開主機·避免發生漏水而導致電腦零件的損壞·

Before fill in water, please make sure all the component be installed correctly, avoiding leaking happen and destroy the PC component.

注意·跑水前·請先確認所有零件已安裝在正確的位置上·在不開主機·單開水泵的情況下·進行24小時的跑水測試·確保無漏水情況後再開主機·避免發生漏水而導致電腦零件的損壞·

本公司保留對產品的設計更改以及解釋的權力·如有更動恕不另行通知·產品顏色與配件以實物為準·

Bitspower reserves the right to change the product design and interpretations. These are subject to change without notice. Product colors and accessories are based on the actual product.

本公司保留對產品的設計更改以及解釋的權力·如有更動恕不另行通知·產品顏色與配件以實物為準·